

## **AOI SEIKO MISTCAPTURE ADVANCED FILTERLESS MIST COLLECTOR**

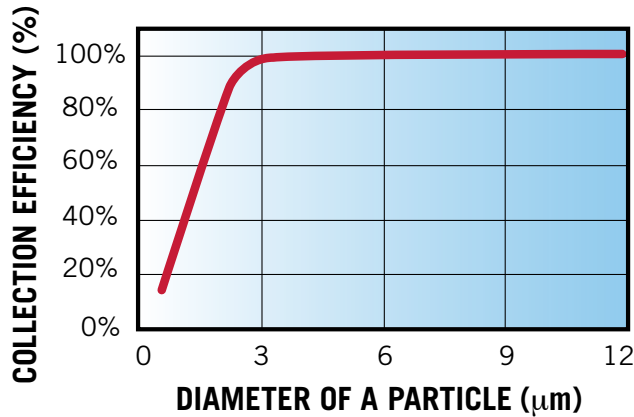

- **98% EFFICIENCY AT 3 $\mu$ m PARTICLES WITH NON-DISPOSABLE FILTERS**
- **COMPACT, SIMPLE MOUNT, EASY MAINTENANCE AND QUIET OPERATION**
- **A SPECIAL IMPELLER DESIGN FOR ADVANCED CENTRIFUGAL SEPARATION**
- **COMPLETELY GREEN AND ENVIRONMENT FRIENDLY PRODUCT**
- **AVAILABLE IN 4 MODELS, DESIGNED FOR A WIDE RANGE OF AIR VOLUMES, VELOCITIES, AND APPLICATIONS**

## AOI SEIKO MISTCAPTURE ADVANCED FILTERLESS MIST COLLECTOR



Mistcapture shown with optional Cyclone and Stand

### SPECIFICATIONS

| SPECIFICATIONS/MODEL                  | AM-5AF  | AM-10AF   | AM-20AF   | AM-30AF   |
|---------------------------------------|---|-----------|-----------|-----------|
| POWER SOURCE                          | Three-Phase 208-230/460V 60Hz                         |           |           |           |
| ELECTRIC MOTOR SPEC (model)           | Totally enclosed, indoor type, fan cooled from flange |           |           |           |
| RPM (min <sup>-1</sup> )              | 3450  |           |           |           |
| OUTPUT (HP x p)                       | 1/2 x 2   | 1.0 x 2   | 2.0 x 2   | 3.0 x 2   |
| CURRENT (A)                           | 2.0   | 3.4 – 3.2 | 5.8 – 5.6 | 8.4 – 7.6 |
| MAX AIR VOLUME (ft <sup>3</sup> /min) | 170   | 290       | 537       | 837       |
| MAX STATIC PRESSURE (kpa)             | 1.1   | 1.32      | 1.96      | 2.30      |
| NOISE (db[A])                         | 64±2  | 68±2      | 73±2      | 73±2      |
| COLLECTION EFFICIENCY (%)             | 98 (3µm particle, soluble mist)                       |           |           |           |
| HIGHEST SUCTION TEMP (°F)             | 140   |           |           |           |
| ROOM TEMP (°F)                        | 14 – 104 (There should be no condensation)            |           |           |           |
| SUCTION PORT DIA. (inches)            | 3.92  | 4.92      | 5.92      | 7.87      |
| WEIGHT (lb.)                          | 127.9   | 176.4     | 231.5     | 253.6     |

### AOI SEIKO MISTCAPTURE ADVANCED FILTERLESS MIST COLLECTOR

#### STANDARD MODEL

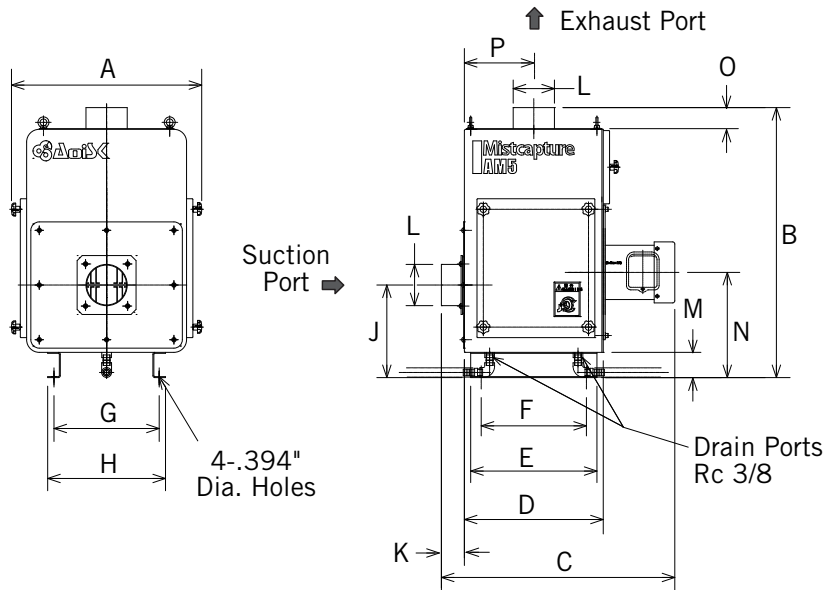

| MODEL   | A    | B    | C    | D    | E    | F    | G    | H    | J    | K   | L   | M   | N    | O   | P    |
|---------|------|------|------|------|------|------|------|------|------|-----|-----|-----|------|-----|------|
| AM-5AF  | 17.7 | 25.3 | 21.7 | 13.0 | 11.8 | 9.8  | 9.8  | 11.0 | 8.7  | 2.2 | 3.9 | 2.4 | 9.8  | 2.0 | 6.5  |
| AM-10AF | 20.5 | 28.0 | 26.0 | 17.7 | 15.7 | 13.8 | 13.8 | 15.0 | 10.2 | 2.2 | 4.9 |     | 11.2 | 2.0 | 8.9  |
| AM-20AF | 22.4 | 32.7 | 28.7 | 19.7 | 17.7 | 15.7 | 15.7 | 16.9 | 11.0 | 2.6 | 5.9 |     | 12.2 | 2.4 | 9.8  |
| AM-30AF | 24.4 | 35.5 | 31.9 | 21.7 | 19.7 | 17.7 | 17.7 | 18.9 | 12.0 | 3.3 | 7.9 |     | 13.2 | 3.2 | 10.8 |

#### STANDARD MODEL WITH OPTIONAL CYCLONE

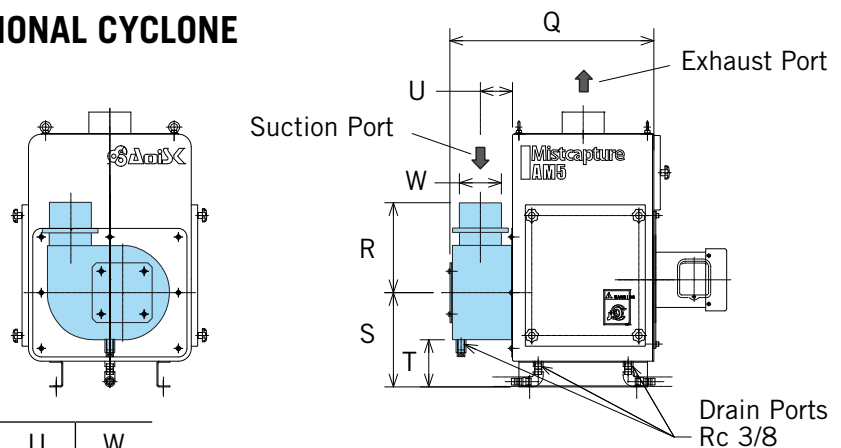







| MODEL  | Q    | R    | S    | T   | U   | W   |
|--------|------|------|------|-----|-----|-----|
| AM-5C  | 18.7 | 8.3  | 8.7  | 4.3 | 3.0 | 3.9 |
| AM-10C | 24.4 | 10.2 | 10.2 | 4.3 | 3.5 | 4.8 |
| AM-20C | 27.4 | 10.6 | 11.0 | 4.7 | 3.9 | 5.8 |
| AM-30C | 32.1 | 14.2 | 12.0 | 5.1 | 5.5 | 7.8 |

Note: Dimensions A~P are the same for standard models and for standard models with optional Cyclone.



### AOI SEIKO MISTCAPTURE ADVANCED FILTERLESS MIST COLLECTOR

#### OPTIONAL ACCESSORIES (MistCapture Side)



| PART NO.  | DESCRIPTION  | PHOTO   |
|---|--|---|
| AM-STAND  | Metal Stand  |    |
| AM-VZ-5<br>AM-VZ-10<br>AM-VZ-20                         | 4" VZ Filter<br>5" VZ Filter<br>6" VZ Filter   |    |
| AM-ELB-5<br>AM-ELB-10<br>AM-ELB-20<br>AM-ELB-30         | 4" Elbow Coupling<br>5" Elbow Coupling<br>6" Elbow Coupling<br>8" Elbow Coupling     |   |
| AM-DMPER-5<br>AM-DMPER-10<br>AM-DMPER-20<br>AM-DMPER-30 | 4" Damper<br>5" Damper<br>6" Damper<br>8" Damper                                     |  |
| AM-CLN-5<br>AM-CLN-10<br>AM-CLN-20<br>AM-CLN-30         | 4" Cyclone<br>5" Cyclone<br>6" Cyclone<br>8" Cyclone                                 |  |
| AM-KA-30  | Anti-Vibration Pad (4/set)   |  |
| AM-DUCT-5<br>AM-DUCT-10<br>AM-DUCT-20<br>AM-DUCT-30     | 4" DUCT HOSE, 25ft<br>5" DUCT HOSE, 25ft<br>6" DUCT HOSE, 25ft<br>8" DUCT HOSE, 25ft |  |

### AOI SEIKO MISTCAPTURE ADVANCED FILTERLESS MIST COLLECTOR

#### OPTIONAL ACCESSORIES CONT. (MistCapture Side)

| PART NO.  | DESCRIPTION  | PHOTO  |
|---|--|--|
| AM-DCLMP-5<br>AM-DCLMP-10<br>AM-DCLMP-20<br>AM-DCLMP-30     | 4" Duct Clamp (Req. 2 pc min.)<br>5" Duct Clamp (Req. 2 pc min.)<br>6" Duct Clamp (Req. 2 pc min.)<br>8" Duct Clamp (Req. 2 pc min.) |   |
| AM-FDMPER-5<br>AM-FDMPER-10<br>AM-FDMPER-20<br>AM-FDMPER-30 | 4" Fire Resistant Damper<br>5" Fire Resistant Damper<br>6" Fire Resistant Damper<br>8" Fire Resistant Damper                         |   |
| AM-FBX-5<br>AM-FBX-10<br>AM-FBX-20<br>AM-FBX-30             | 4" Filter Box<br>5" Filter Box<br>6" Filter Box<br>8" Filter Box   |  |

#### OPTIONAL ACCESSORIES (Machine Side)

| PART NO.  | DESCRIPTION  | PHOTO   |
|---|--|---|
| AM-AFG-5<br>AM-AFG-10<br>AM-AFG-20<br>AM-AFG-30 | 4" Straight Duct Adapter<br>5" Straight Duct Adapter<br>6" Straight Duct Adapter<br>8" Straight Duct Adapter |  |
| AM-LFG-5<br>AM-LFG-10<br>AM-LFG-20<br>AM-LFG-30 | 4" L-Shaped Duct Adapter<br>5" L-Shaped Duct Adapter<br>6" L-Shaped Duct Adapter<br>8" L-Shaped Duct Adapter |  |